

*Thank you for choosing a NIVELCO instrument.
We are sure that you will be satisfied throughout its use.*



UNICONT
PMG-411, PMG-412, PMG-413
UNIVERSAL CONTROLLER

USER'S MANUAL



1. APPLICATION

The UNICONT PMG-411, PMG-412 and PMG-413 universal analogue PID-controllers can be used with a Pt-100 resistance thermometer and with different thermocouples for temperature measurement, control as well as processing the signals of transmitters with 4 ... 20 mA and 1...5 V DC or 0...10 V DC output. The output signal of the controller can be a relay, continuous 4 ... 20 mA process current signal or SSR-driver. Additional alarm relay provides for limit monitoring. The unit is microprocessor based, has an auto-tuning software, automatic and its PID controller able to find the optimum of the P-I-D constants. The setting can be performed by the keyboard on the front side. The large bi-coloured display provides easy reading even from far distance. The process parameters are red, the set values are green.

2. TECHNICAL DATA

TYPE		PMG-411-; -412; -413-	
Input	Resistance thermometer (3 cable, aut. cable compensation)	DIN Pt 100 (-199.9 °C...+199.9 °C or 0 °C...+500 °C) R cable: max. 5 Ohm	
	Thermocouple (aut. cold junction compensator)	K (-100 °C...+1100 °C); J (0 °C...+800 °C)	
		R (0 °C...+1700 °C); E (0 °C...+800 °C)	
		T (-200 °C...+400 °C); S (0 °C...+1700 °C)	
N (0 °C...+1300 °C); W (0 °C...+2300 °C)			
Voltage	1...5 V DC; 0...10 V DC		
Current	4...20 mA DC / 250 Ohm		
Control output	PID (auto-tuning)	Proportional range (P)	0...100%
		Integral time (I)	0...3600 s
		Derivative time (D)	0...3600 s
		Cycle time (C)	1...120 s
	Output	Relay	SPDT; 250 V AC, 3 A, AC1
SSR driver		12 V DC ±3 V, max. 30 mA	
Current		4...20 mA DC (max. load 600 Ohm)	
Alarm output	SPST programmable relay, 250 V AC, 1 A, AC1		
Setting and display accuracy		±0,3 % ±1 digit for the whole input scale or ±3 °C	
Display	PV (process variable)	4 digit, 7 segment 11 mm high red LED	
	SV (set value)	4 digit, 7 segment 7 mm high green LED	
Power supply		90...264 V AC 50/60 Hz, max. 5 VA	
Protection		Front side: IP 65, Back side: IP 20	
Electronic protection		Class II Reinforced Isolation	
Ambient temperature		Operational: -10...+50 °C, Storing: -20...+60 °C	
Ambient humidity		35 ... 85% RH	
Dimensions		48 x 48 x 107 mm (panel cut out: 45.5 ^{+0.5} x 45.5 ^{+0.5} mm)	
Weight		0.15 kg	

Manufacturer:
NIVELCO Process Electronics Co.
1043 Budapest, Dugonics u. 11.
Phone: 36-1 369-7575 ♦ Fax: 36-1 369-8585
e-mail: sales@nivelco.com www.nivelco.com

2.1. ACCESSORIES

- 1 User's Manual
- 1 Warranty Sheet
- 1 Declaration of Conformity
- 1 Fixing bracket, 2 screws

2.2. ORDER CODE

UNICONT P M G - 4 - 1

Input	Code	Output	Code
1 Universal input	1	2 relays	1
		SSR driver	2
		4...20 mA	3

2.3 FRONT PANEL

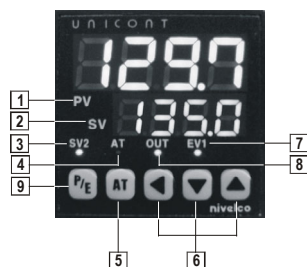

- 1 PV: Process value display (red)
- 2 SV: Set value display (green)
- 3 SV2: If this LED is ON, the second, internal set point is effective.
- 4 AT LED: Flashing during auto tuning
- 5 AT key: auto tuning operation
- 6 ◀ ▶ ▼: Display setting keys
- 7 EV1: Indicates the alarm output
- 8 OUT: Indicates the output
- 9 P/E key: Enters/ escapes programming

3. DIMENSIONS

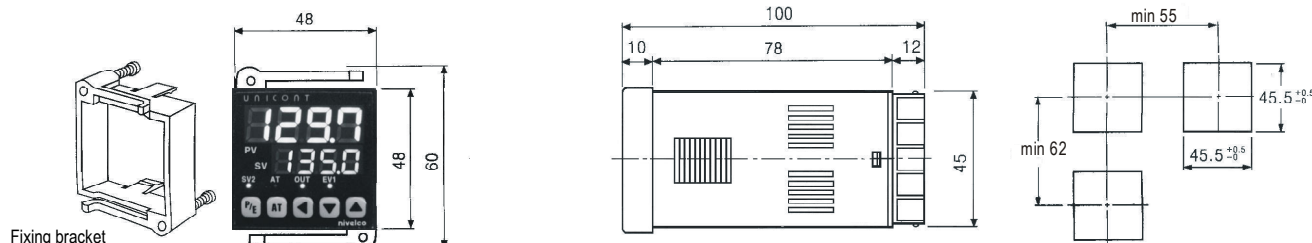

4. WIRING

U_s : Power Supply
 OUT : Control Output
 IN1 : Sensor Input
 AL1 : Alarm Output
 IN2 : Processor Input

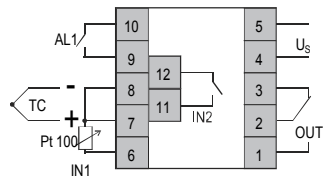

PMG-411

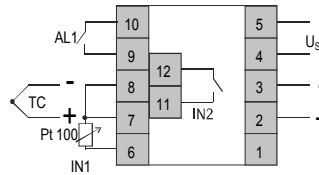

PMG-412

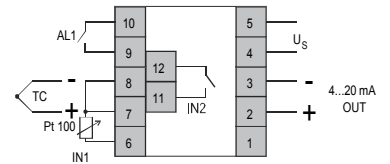

PMG-413

5. PROGRAMMING

Program menu can be entered by long and simultaneous pressing of the P/E and ▲ keys (t > 3 s)

If no key is pressed within 20 s, factory setting (DEFAULT) will be returned.

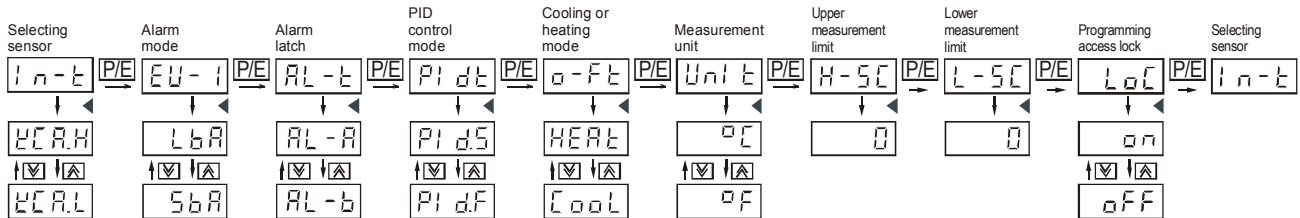

PROGRAM MENU

In-t	Input
EU-1	Alarm mode
AL-t	Alarm latch
Pidt	PID control algorithm
o-Ft	Cooling or heating control
Unit	Engineering unit of the temperature measurement unit
H-Sc	Upper measurement limit
L-Sc	Lower measurement limit
LoC	Programming access lock

SETTING THE CONTROL PARAMETERS Control parameters can be entered by pressing key P/E longer than 3 s

SU-2	Setting second (internal) set point. Effective with the short circuit of input IN2
AL-1	Setting operation value of the alarm relay (if operation selected in EV-1 menu)
LbA	Setting delay of the loop break indication relay output (0 ... 999 s) (if operation selected in EV-1)
P	Setting proportional band from 0 % to 100 %
I	Setting integral time from 0 to 3600 s
d	Setting derivative time from 0 to 3600 s
t	Setting cycle time of the control relay from 1 to 120 s
HIS	Setting switching difference from 0 to 100 °C for ON/OFF control
In-b	Modifying the measured value between -49 and +50 °C. Also applicable with calibration (OFFSET function)
rESE	Setting proportional control range from 0 to 100 % (for control only)
rAPU	Setting rising gradient for RAMP mode if heating (settable range of time to reach the SV: 1 to 99 min)
rAPd	Setting rising gradient for RAMP mode if cooling (settable range of time to reach the SV: 1 to 99 min)
LoC	<p>Access lock</p> <p>ON OFF</p> <p>If the access lock is active no parameter can be entered</p>

CHANGING THE SET POINT

- Pressing key ▲ set value will be flashing
 - Using key ▲▼ the required parameter value can be set
 - Pressing key ▲ again the next parameter will be reached
- Confirm settings with the key P/E.

SETTING THE ON/OFF CONTROL

- Set the PID parameters to zero
- The „HIS” code will be displayed. The switching difference can be set in this menu if needed.
- Measurement range : 0...100 °C or 0...10.0 °C, depending on the decimal point

SELECT INPUT WITH MEASUREMENT RANGE

DISPLAY	INPUT	RANGE	REMARKS
YCR.H	K thermocouple	-100...+1300 °C	
YCR.L	K thermocouple	-100...+999 °C	Reduced
JIC.H	J thermocouple	0...+800 °C	
JIC.L	J thermocouple	0.0...+800.0 °C	Decimal point
rPr	R thermocouple	0...+1700 °C	
ECr.H	E thermocouple	0...+800 °C	
ECr.L	E thermocouple	0.0...+800.0 °C	Decimal point
TCr.H	T thermocouple	-800...+400 °C	
TCr.L	T thermocouple	-199.9...+400.0 °C	Decimal point
SPr	S thermocouple	0...+1700 °C	
Nn	N thermocouple	0...+1300 °C	
Wt	W thermocouple	0...+2300 °C	
JPt.H	J: Pt 100	0...+500 °C	
JPt.L	J: Pt 100	-199.9...+199.9 °C	Decimal point
dPt.H	DIN Pt 100	0...+500 °C	
dPt.L	DIN Pt 100	-199.9...+199.9 °C	Decimal point
A--1	0 ... 10 V DC	-199.9 ... +9999	Jumper setting and scaling are needed
A--2	1 ... 5 V DC	-199.9 ... +9999	
A--3	4 ... 20 mA	-199.9 ... +9999	

ALARM EVENTS

Only the alarm event can be indicated on the display, which has been selected in menu Alarm Events.

LbA	—	Current loop break
SbA	—	Sensor break
AL-0	—	Alarm relay failure
AL-1		PV exceeding the relative upper limit value. $PV > SV + AL1$
AL-2		PV exceeding the relative lower limit value. $PV < SV - AL1$
AL-3		PV is outside the range of the SV
AL-4		PV is within the range of the SV
AL-5		PV exceeding the absolute upper limit value. $PV > AL1$
AL-6		PV exceeding the absolute lower limit value $PV < AL1$

Remark: „h“ = 2 °C switching difference is fixed.

ALARM RELAY DISABLING

MODE	OPERATION	DESCRIPTION
AL-A	Standard	No latch
AL-b	Latch	Remains latched after triggering. Release by selecting AL-A.
AL-E	Standby Latch	No triggering at first reaching of PV SV. The output does not switch on if the PV first reaches the set point (SV). It triggers only if PV differs from the SV and reaches the alarm value.
AL-d	Latch and Standby	Simultaneous use of latching and standby order.

SETTING THE ANALOGUE INPUT

Pushing both fasteners on the back side, the instrument can be pulled out of the box. There are two jumpers (S/W1 and S/W2) inside the instrument. The jumpers can be carefully pushed off and pulled back according to the figure below.

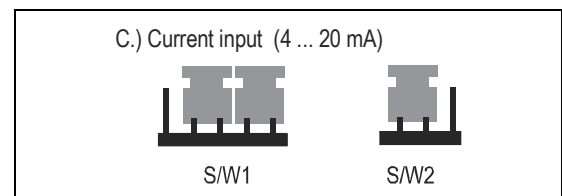
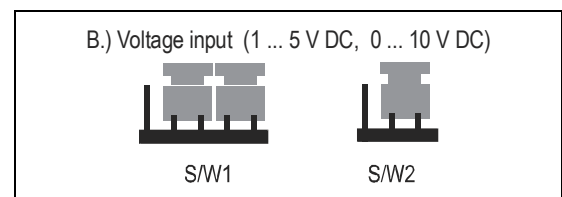
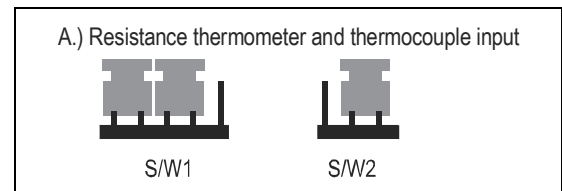

SV-2 OPERATION (INTERNAL SET POINT)

The SV can be seen on the lower green display and set by the keys on the front panel.

There is a possibility to set a second internal SV in the SV-2 menu, which is effective with the short circuit of the input points IN2.

MEASURED VALUE OFFSET (PARAMETER In-b)

Displayed value can be shifted with any value in the parameter In-b menu (Offset Function). This can be applied for instance for cable compensation with temperature measurement of two wire Pt 100.

SCALING

Measurement range will automatically be determined with the use of Pt 100 or thermocouple. For analogue inputs (4...20 mA, 0...10 V DC, 1...5 V DC) the low and the high values have to be entered in menu L-SC (low value) or H-SC (high value).

SETTING RISING TEMPERATURE GRADIENT (RAMP)

The required delay can be set in the rAPU menu for heating and in rAPd for cooling is needed. After reaching the new SV, will be kept by the controller.

6. CONTROL ALGORITHM

There are three different control algorithms, which can be set by the UNICONT PMG-411, -412 unit.

- ON / OFF control
- Proportional (P) control
- PID control

The best accuracy can be achieved by PID control. The PMG-413 unit with analogue output can only be used as PID controller.

It is essential to define the control characteristic: whether heating or cooling is needed.

COOLING/HEATING CONTROL

The unit is able to control the cooling/heating process and it can also be used for level control. The filling control corresponds with the heating algorithm and the emptying control with the cooling algorithm.

The algorithm can be selected in menu o-Ft.

- Select HEAT: heating or filling control
- Select Cool: cooling or emptying control

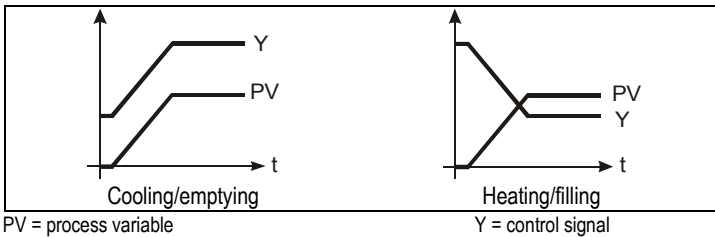

ON / OFF CONTROL

Setting the PID parameters to zero the unit can be operating as an ON/OFF controller.

In this case the controller offers a settable symmetrical switching difference in the menu HIS.

The heating or cooling algorithm should be set (see menu o-Ft)

PROPORTIONAL (P) CONTROL

In case of proportional control the value of gain (P) is other than zero but the integral and derivative times are zero. The proportional gain can be set between 1...100%. Control will be accomplished by changing the time of the relay's energised and de-energised state within its cycle time. The cycle time of the relay can be set in the menu T between 1...120 s.

Proportional band: the control range of the cycle. Out of the proportional band the relay is always energised or de-energised.

The proportional baude: $q = P (\%) \cdot \Delta M$

where $\Delta M =$ measurement range.

The location of the proportional band compared to the SV depends on the percentage value in the menu rEST. If rEST value = 0%, the whole range is under the SV.

- If rEST value = 0 %, the whole band is under the SV.
- If rEST value = 50.0 %, the proportional band is symmetrically situated to the SV
- If rEST value = 100 %, the proportional band is situated over the SV

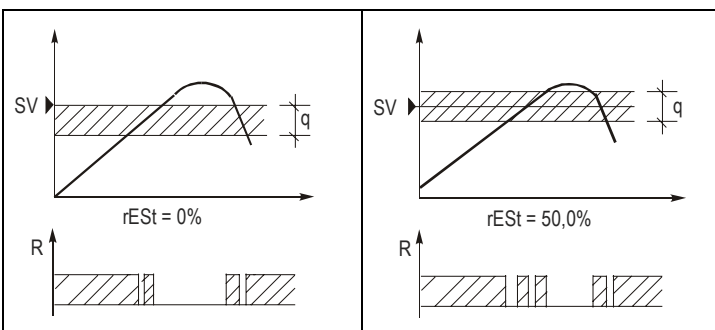

Relay operation depending on rEST percentage by proportional control

PID CONTROL

The PID control is the most commonly used control mode. Similar to the proportional control PID control will be accomplished by changing the relay's energised and de-energised states within its cycle time. Since determination of the PID parameters by the manual trial and error method the use of the AT mode is suggested.

AT MODE

Sensing characteristic features of the control process, the unit determines automatically the PID parameters and the cycle time.

AT mode will be started by pressing key AT at least 3 s.

During the auto tuning the AT-LED will be blinking and it will turn off if completed. Auto tuning can be interrupted by pressing key AT for longer than 3 sec. Auto tuning procedure is suggested to repeat from time to time since thermal features may be changed.

PID RAMPING MODES

There are two different ramping modes

With the first one, the PV reaches the SV with high speed. In this case a minor overshoot will occur (Fig. 1.), by the second one the PV reaches the SV slower but without overshoot (Fig. 2.)

Selecting and setting can be performed in the Pidt menu. PidF means the fast and PidS the slow setting.

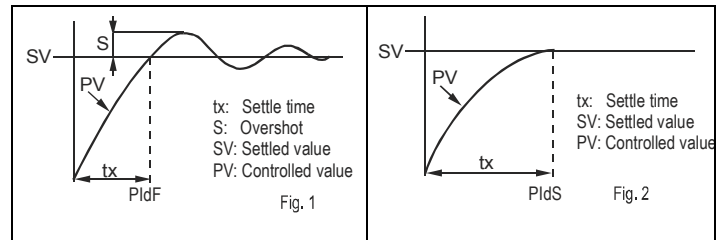

7. FAULT INDICATION

The unit provides for fault indication if it does not work correctly.

The fault indication can be a text on the display or triggering of the Alarm relay.

Fault indications on the display

There are three kinds of fault indications:

- „LLLL” the measured value is under the lower measurement limit (it is probable an incorrect input choice)
- „HHHH” the measured value is over the upper measurement limit (the input signal has not been correctly choosen)
- „OPEN” the sensor input screw terminal is open (the wire is loose or cut)

Fault indications by the Alarm relay

The Alarm relay can be programmed for two alarm events.

Selecting „LbA” Menu Point: In case of a unit failure the relay will be triggered with a delay set in Parameter Menu (See SETTING CONTROL PARAMETERS)

Selecting „SbA” Menu Point: In case of sensor cut the relay will be triggered with a dely set in Parameter Menu (See SETTING CONTROL PARAMETERS)

8. STORAGE CONDITIONS

Ambient temperature: -25...+60°C

Air moisture: max. 98 %

9. WARRANTY

Warranty: two years after the purchase. It can only be validated if presenting both the warranty sheet and the invoice.

The warrantial repair is carried out at the manufacturer's seat so the costs of dismantling and mounting as well as the shipping charge the customer. The manufacturer accepts the instruments only accurately cleaned or disinfected. We do not guarantee faults because of irregular use, break and elemental damage.